

Varenummer: 03493030  
Beskrivelse: Fluro Heavy Duty Ledhoved EAL 30 EW-2RS  
M30x2 Udvendig gevind  
Note: 30

## Mål

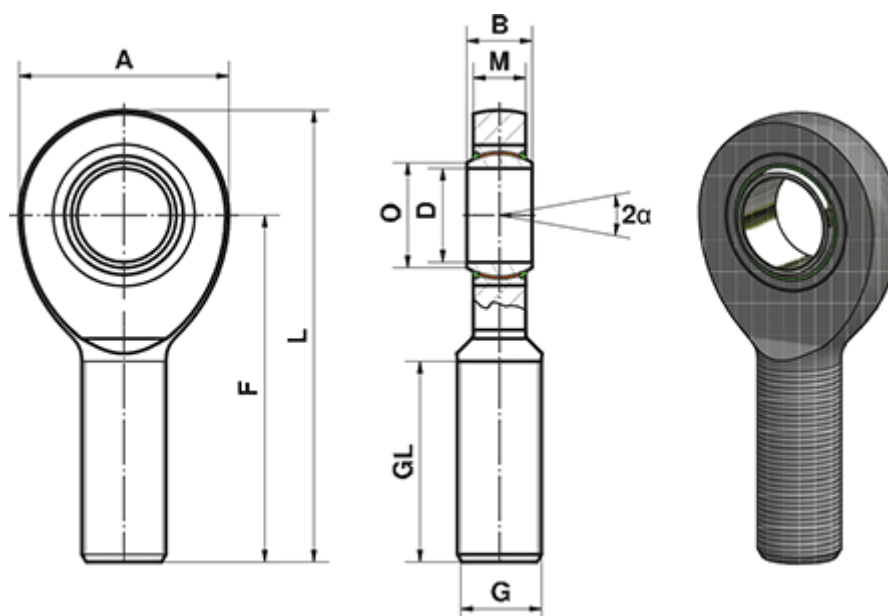

A	= 73	L	= 146.5
a (grader)	= 6	M	= 18
B	= 22	O	= 34.2
D	= 30	Statisk belastning C0 (kN)	= 124
Dynamisk belastning C (kN)	= 165	Vægt (g)	= 890
F	= 110		
G	= M30x2		
GL	= 65		